

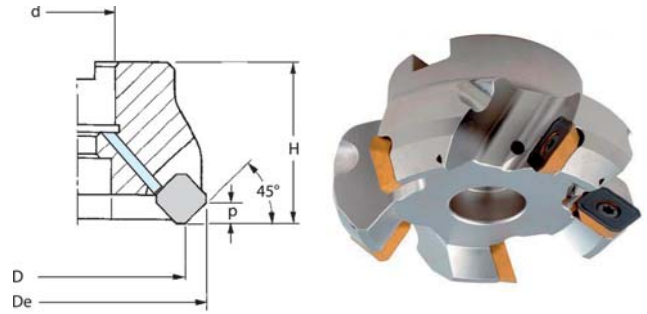

Fresa ad inserti per spianatura a 45° con attacco a manicotto

Fresa ad inserti per spianatura a 45° a passo differenziato, **con passaggio interno del lubrorefrigerante**, (ad esclusione dei diametri 160, 200 e 250 mm), geometria positiva utilizzabile su macchine con potenze medie.



Codice	€	Dimensioni					
		D (mm)	De (mm)	d (H7) (mm)	H (mm)	p (mm)	Z
A58010050	◆	50	63	22	40	6	4
A58010063	◆	63	76	22	40	6	5
A58010080	◆	80	93	27	50	6	6
A580100100	◆	100	113	32	50	6	7
A580100125	◆	125	138	40	63	6	8
A580100160	◆	160*	173	40	63	6	10
A580100200	◆	200*	213	60	63	6	12
A580100250	◆	250*	263	60	63	6	16

*Senza fori passaggio lubrorefrigerante.

Ricambi		
Inserto	Vite	Giravite
SEHT 13T3	A910350030	N202350150

Inserti: vedi pag. 400/401/402/403/404/405.



Fresa ad inserti per spianatura a 45° con attacco a manicotto

Fresa ad inserti per spianatura a 45° a passo differenziato, **con passaggio interno del lubrorefrigerante**, dalla geometria negativa utilizzabile su macchine con potenze medio alte.

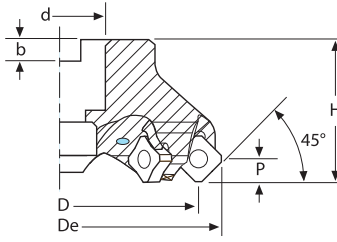

Assortimento



Codice	€	Dimensioni					
		D (mm)	De (mm)	d (H7) (mm)	H (mm)	p (mm)	Z
A580130050	◆	50	63	22	40	6	4
A580130063	◆	63	76	22	40	6	6
A580130080	◆	80	93	27	50	6	7
A580130100	◆	100	113	32	50	6	8
A580130125	◆	125	138	40	63	6	10
A580130160	◆	160	173	40	63	6	12
A580130200	◆	200	213	60	63	6	14
A580130250	◆	250	263	60	63	6	16
A580130500	◆	50	63	22	40	6	6
A580130630	◆	63	76	22	40	6	8
A580130800	◆	80	93	27	50	6	10
A580131000	◆	100	113	32	50	6	12
A580131125	◆	125	138	40	63	6	16
A580131160	◆	160	173	40	63	6	20

Ricambi		
Inserto	Vite	Giravite
SNEX SNKX SNMX 1206 SNMU 1206 ONMU 1205	A910350045	A559250100

Inserti: vedi pag. 400/401/402/403/404/405.

Codice	€	Assortimento di frese
Composto da		
A580139000	◆	1 fresa cod. A580130050 + 10 inserti SNMU 1206 ANER cod. A932051550 + 10 inserti ONMU 1205 ANN cod. A932100550
A580139005	◆	1 fresa cod. A580130063 + 10 inserti SNMU 1206 ANER cod. A932051550 + 10 inserti ONMU 1205 ANN cod. A932100550
A580139010	◆	1 fresa cod. A580130080 + 10 inserti SNMU 1206 ANER cod. A932051550 + 10 inserti ONMU 1205 ANN cod. A932100550

◆ Spedizione da magazzino CDU ◇ Spedizione da magazzino esterno